



Portable Air Conditioner with Heat Pump Operating Instructions



*Model No.: PH5-13R-32D
Reference No.: LX-130DHP*

Thank you for choosing a Soleus Air PH5 Series Portable Air Conditioner. This owner's manual will provide you with valuable information necessary for the proper care and maintenance of your new product. Please take a few moments to thoroughly read the instructions and familiarize yourself with all the operational aspects of your new Soleus Air Portable Air Conditioner.

For your own records, please attach a copy of your sales receipt to this manual. Also, write the store name/location, date purchased, and serial number below:

Store Name: _____

Location: _____

Date Purchased: _____

Serial Number (located on back of unit): _____

IMPORTANT INSTRUCTIONS

Before installing and using your portable air conditioner, please read this owner's manual carefully. Store this manual in a safe place for future reference.

- 1) Always place the unit on a level surface.
- 2) Never use or store gasoline or other flammable vapor or liquid near this unit unless instructed by this manual.
- 3) Maintain at least 10 inches (25 cm) clearance space around this unit. Do not block or cover air inlet or outlet grilles.
- 4) The unit must be connected to a correctly grounded power supply.
- 5) Do not start or stop the unit by inserting or pulling out the power plug.
- 6) Do not use an adapter plug or extension cord.
- 7) Do not use the unit in the immediate surroundings of a bath, a shower or a swimming pool.
- 8) Do not insert anything into the air outlet. Do not obstruct air inlet or outlet grills unless instructed by this manual.
- 9) Do not let children play near this unit.
- 10) Always inspect the cord for signs of damage before use. If the power cord is damaged, it must be replaced by the manufacturer or a qualified service technician.
- 11) When cleaning the unit, always turn the unit off and unplug the power cord.
- 12) Do Not Mix Old And New Batteries.

Do Not Mix Alkaline, Standard (Carbon - Zinc), Or Rechargeable (Nickel - Cadmium) Batteries

35+Y j gp"ej cpi kpi "dgwy ggp"j gcvkpi "cpf "eqqrkpi "o qf g"vj gtg'y km'dg"5/7"o kpwg"t grc{ "hqt"vj g"eqo r tguuqt "q"uvtv0
*****F wtkpi "vj ku"ko g."vj g"tghki gtcpv"pkuf g"vj g'r qtvdng"ckt"eqpf kkppt"y km'tgwtp"q"vj g"eqo r tguuqt "q"uvtv"j gcvkpi "qt
*****eqqrkpi "{qwt"ctgc0

PACKAGE CONTENTS

Portable Air Conditioner
 Exhaust Hoses (2)
 Hose Adapters (2)
 Window Kit Adapter (2)
 Remote Control
 AAA Batteries (2)
 Window Kit - 3 Sliding Panels
 Air Outlet Covers (2)
 Owner's Manual

SPECIFICATIONS

- The cooling capacity is measured at an ambient temperature of DB 86 °F, WB 78 °F.
- The operational ambient temperature is between 23°F ~ 109°F.
- Noise level is measured at a distance of 3.28 ft away from the front of the unit, when the unit is in cooling mode.
- Power consumption is measured when the fan runs at the highest speed setting.
- These specifications are for reference only. For actual data, please refer to the rating label on the back of the unit.
- If the ambient temperature is higher than the max operating temperature or lower than the minimum operating temperature, the air conditioner may not work properly.

MODEL NUMBER		PH5-13R-3GD
ÜÖÖÜÖPÖÖÄWT ÖÖÜ		ŠYĚHEÖPÚ
COOLING CAPACITY		13,000 BTU/H
HEATING CAPACITY		12,500 BTU/H
DEHUMIDIFIER CAPACITY		60 pts/Day
POWER	COOLING	1350W
	HEATING	1160W
AIR FLOW VOLUME		225 CFM
POWER SOURCE		115 V~ 60 Hz 10.5 AMPS Heating 12 AMPS Cooling
SOUND PRESSURE LEVEL		46 dB(A)
NET WEIGHT		88 Lbs
OPERATING TEMP	COOLING	60.8°F-109°F
	HEATING	23°F-89.6°F
DIMENSIONS	UNIT	18.875" W × 32" H × 17.125" D
REFRIGERANT		R-410A

LCDI POWER CORD AND PLUG

This air conditioner is equipped with an LCDI (Leakage Current Detection and Interruption) power cord and plug as required by US National Electric Code 440.65. This cord consists of a length of shielded flexible cord with no termination on the load side and a LCDI attachment plug on the line side.

The LCDI power cord and plug will remove the supply source via electrical disconnect (circuit trip) if the nominal current leakage between the cord shield and either load conductor exceeds a predetermined value. The cord will remain de-energized until the device has been manually reset. This is intended to reduce the risk of a fire in the power cord or combustible materials nearby. The cord shields are not grounded and they must be considered a shock hazards if exposed. The cord shield must not be connected to ground or to any exposed metal.

The test and reset buttons on the LCDI Plug are used to check if the plug is functioning properly. To test:

1. Plug power cord into wall outlet
2. Press TEST Button, circuit should trip, cutting power to the air conditioner
3. Press RESET button for use

If test button is pressed and unit can still be turned on, current leakage has been detected. Do not use the air conditioner or attempt to reset the LCDI Plug. Contact Soleus Air Customer Service for troubleshooting recommendations.

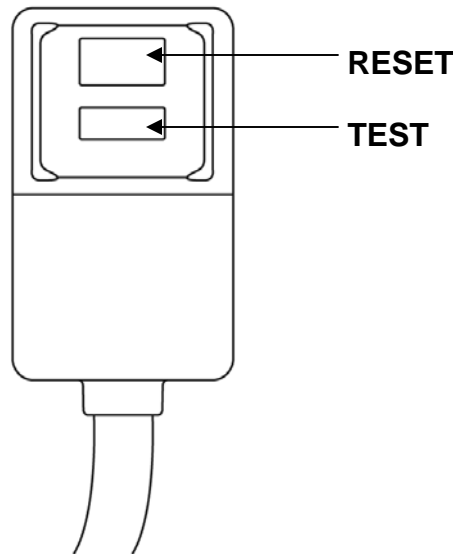

WARNING:

1. DO NOT press the TEST button while the air conditioner is operating.
2. The TEST and RESET buttons should not be used as “ON” and “OFF” switches.
3. The cord and plug are not intended to offer protection to externally connected loads or supply circuits.
4. The cord and plug are intended for indoor use only.

PRODUCT DIAGRAM

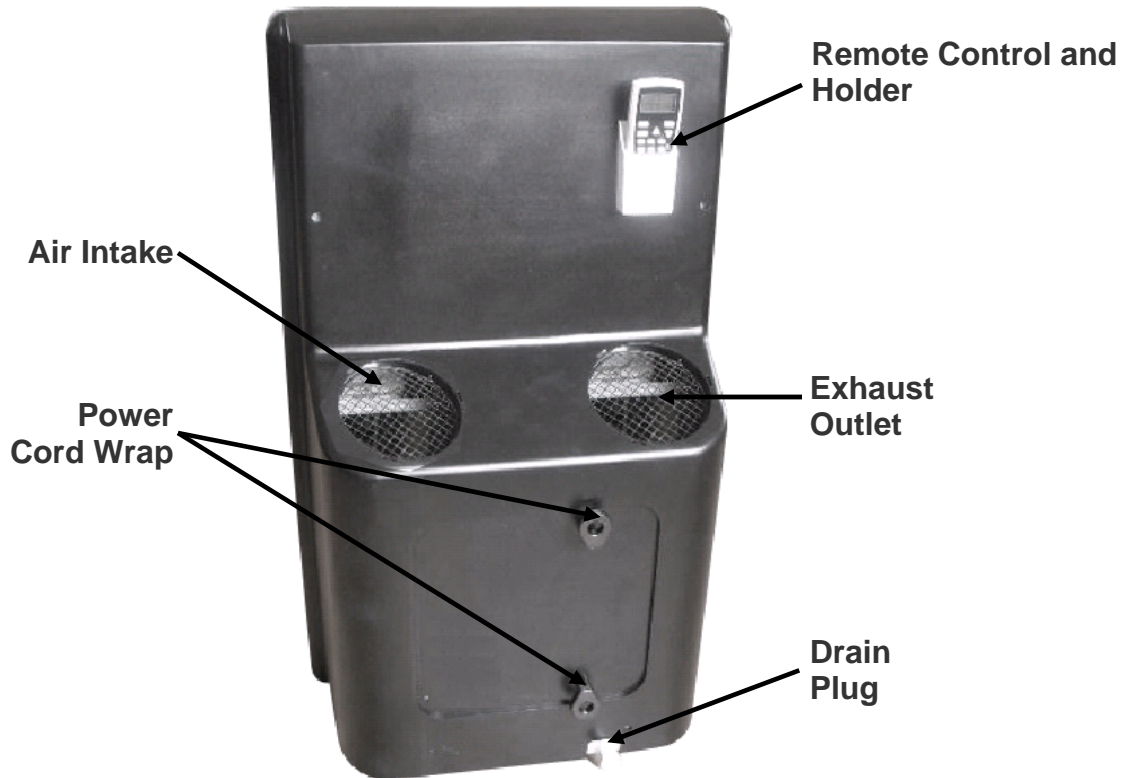

PARTS & ASSEMBLY

PARTS

EXHAUST HOSES (2 Included)

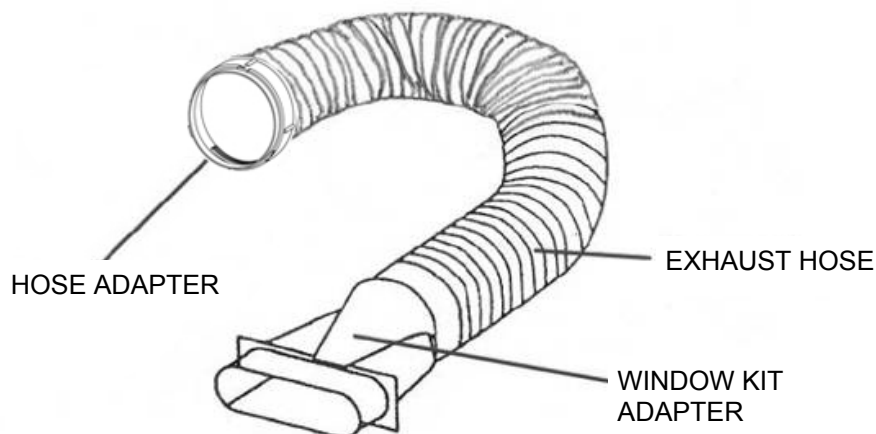

WINDOW KIT

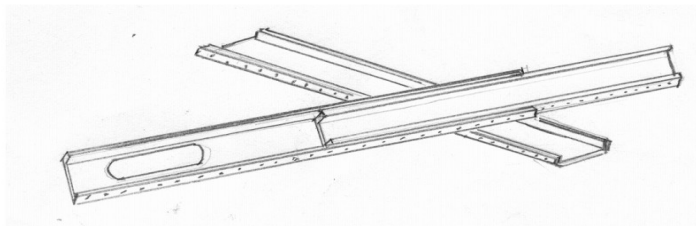

ASSEMBLY & INSTALLATION

INSTALLATION

When the unit is operating as an air conditioner, heater, or dehumidifier, the unit draws in fresh outdoor air and exhausts hot air (or cold air in heat mode) out of the room to complete the air exchange. When the unit is operating in fan mode, no outdoor air exchange takes place. The window kit and exhaust hose do not need to be installed when the unit is used as a fan.

NOTE: The supplied window kit can be installed in sliding windows and sliding glass doors up to 8 ft. long (approximate length).

MOUNTING THE EXHAUST HOSE

- Choose a suitable location, near a grounded electrical outlet and suitable window or door. Remove packaging and locate components.
- Extend both ends of the exhaust hose approximately 6 inches.
- Screw the window kit adapter onto one end of the exhaust hose clockwise. Screw the hose adapter onto the other end of the exhaust hose clockwise.
- Remove the outlet cover from the back of the unit by screwing them counter-clockwise, then lifting up.
- Mount the exhaust hose onto the back of the unit by locking the hose adapter into place.

VENTING KIT INSTALLATION



Innovative products for a cleaner,
more comfortable world.

Installation of the Venting Kit

FOR **DUAL HOSE** PORTABLE AIR CONDITIONERS

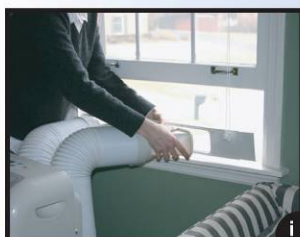
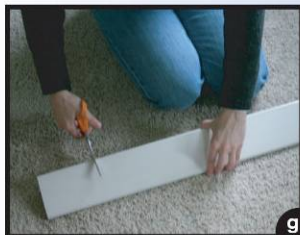

The venting kit must be installed in order for the unit to work correctly in the air conditioning, heating or dehumidifying mode. The venting kit does not need to be used while the unit is fanning.

The window kit has been designed to fit into most vertical and horizontal window openings. The window kit can also be used in a sliding door.

1. Choose a suitable location, near a grounded electrical outlet and a suitable window or door. Remove packaging and locate components. (figure a)
2. Remove the outlet covers from the back of the unit by screwing them counter-clockwise, then lifting up. (figure b)
3. Pull out one end of the exhaust hose, then screw on the adapter clockwise. Repeat on other exhaust hose. (figure c)
4. Pull out the opposite end of the exhaust hose, then screw on the window kit adapter clockwise. Repeat on other exhaust hose. (figure d)
5. Mount the exhaust hoses onto the back of the unit. (figure e)
6. Open the window or door and adjust the length of the window kit to fit the opening. (figure f) If necessary, mark the kit and cut down one end to properly fit the opening. (figures g & h)
7. Attach the window kit adapters to the window kit. (figure i) Close the window or door tightly. (figure j)
Your Portable Air Conditioner is now ready to cool!

NOTE: When using the venting system, keep the exhaust hose as short and straight as possible. The exhaust hose can be shortened, but it is not recommended to increase the length of the exhaust hose. Do not use an extension cord with your portable air conditioner.

NOTE: The Portable Air Conditioner above may differ from the unit described in this manual. The above directions and images show **general** directions for Soleus Air hose portable air conditioners.

WINDOW KIT ASSEMBLY

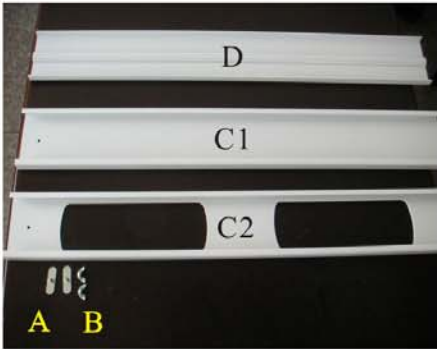

1. Parts:

- A) 2 Track Screws
- B) 2 Wing Nuts
- C1 & C2) 2 Hose Panels, one Exhaust Hose Openings
- D) 1 Sliding Track Panel



2. Assembly:

First, take the Track Screws (A) and screw one into each of the small holes found on the Hose Panels (C1 & C2).

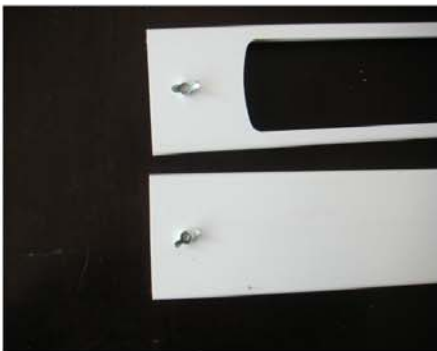

3. Next, take the Wing Nuts (B) and tighten them around each of the Track Screws (A). Do not tighten the Wing Nuts (B) all the way; make sure they are somewhat loose.



4. Now, place the Sliding Track Panel (D) over the Track Screw (A) on Hose Panel (C1).

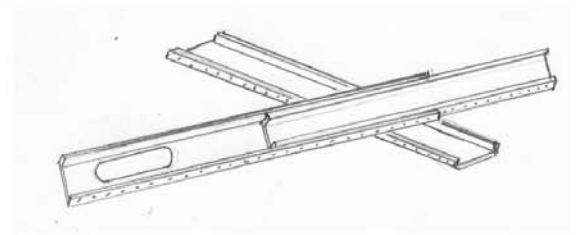

5. Next, take the other Hose Panel (C2) and connect it to Hose Panel (C1) by placing the Sliding Track Panel (D) over the Track Screw (A) on Hose Panel (C2).

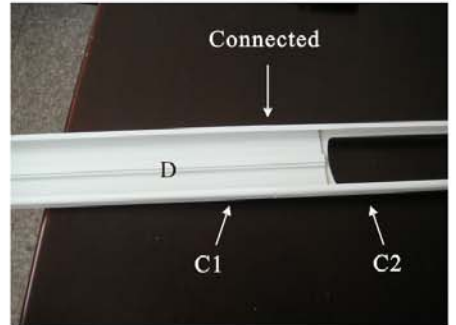

6. The Hose Panels (C1 & C2) should now be connected using the Sliding Track Panel (D).

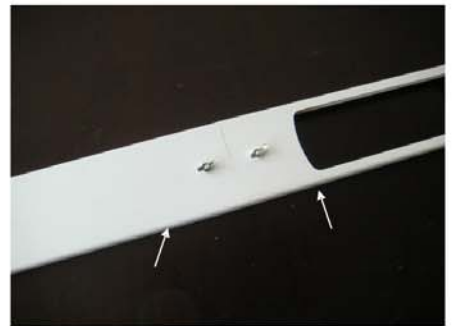

7. To complete the assembly, tighten the wing Nuts (B) installed earlier. The finished Window Kit should resemble the image seen below.

CONTROL PANEL, DISPLAY, & OPERATING INSTRUCTIONS

CONTROL PANEL & LED CONTROL DISPLAY

CONTROL PANEL

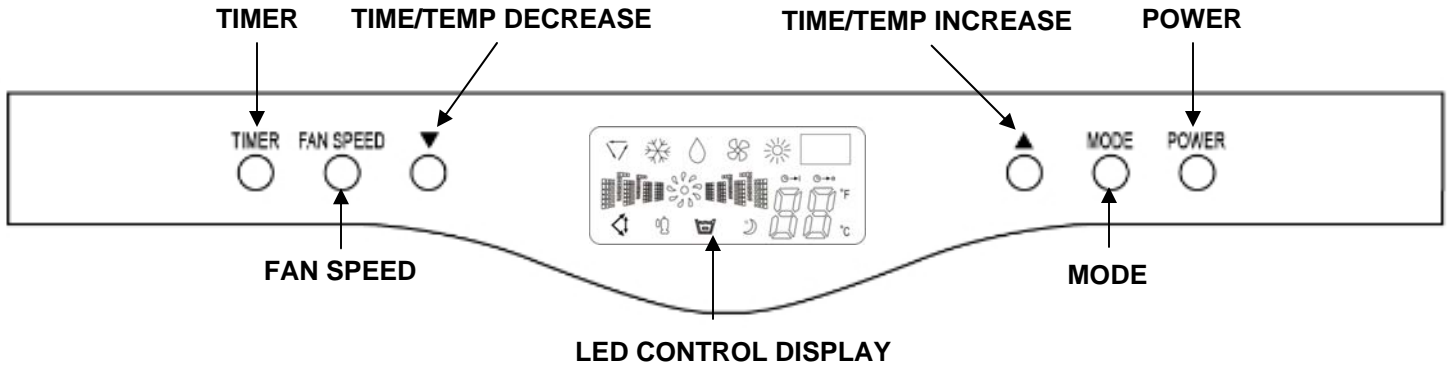

LED CONTROL DISPLAY

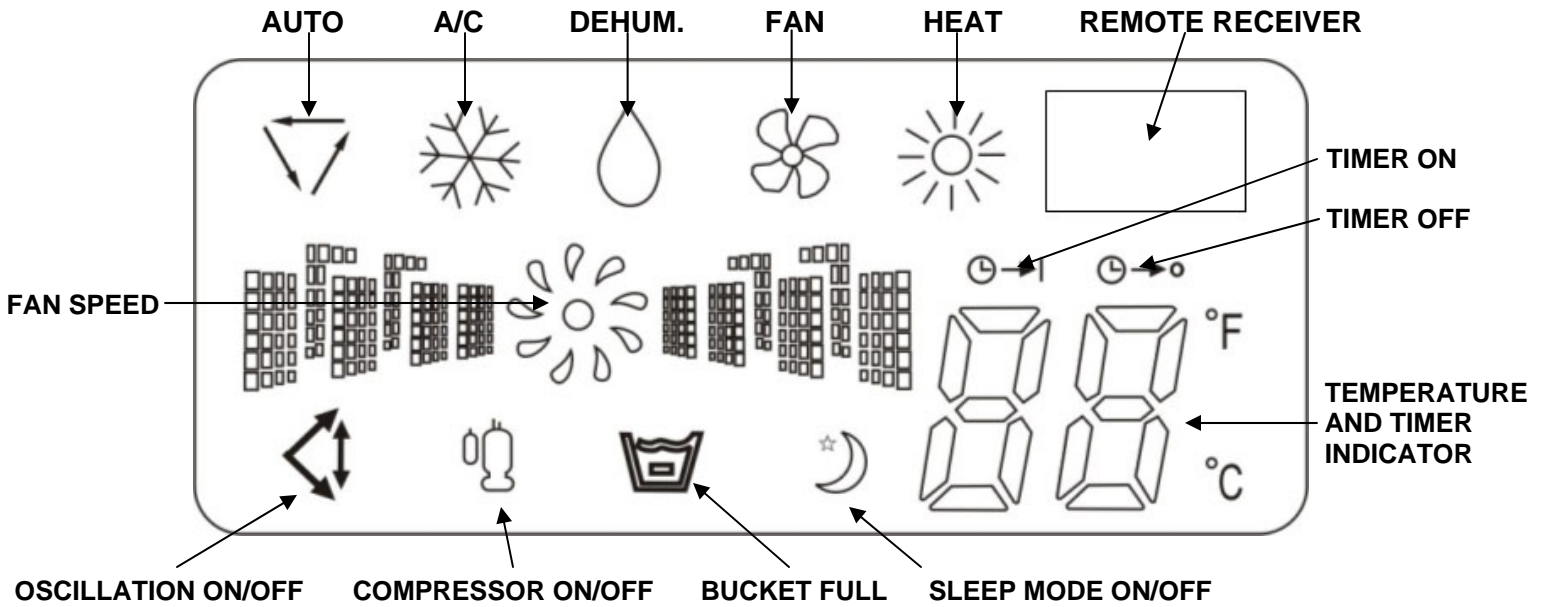

CONTROL PANEL, DISPLAY, & OPERATING INSTRUCTIONS

CONTROL PANEL BUTTONS (Refer to the images on page 9)

- 1) **Power On and Off** - Press the **POWER** button once to manually turn the unit on. Press the **POWER** button once more to turn the unit off.
- 2) **Mode Selection** - Press the **MODE** Button repeatedly to cycle between the different modes: Auto mode, Air Conditioner, Dehumidifier, Fan only, and Heater mode.
- 3) **Fan Speed Control** - Press the **FAN SPEED** Button to cycle through the different fan speeds: **High, Medium, and low**. The fan speed can be visually distinguished by the speed of the digital air segments progressing out from the windmill fan image on the led control display. There is an additional **auto** speed setting that is enabled in only heating and cooling modes. This speed is next setting after low when pressing the speed control button. The speeds will cycle through in this order: **High, Medium, Low, Auto**. Each change in speed will be associated with a “beep” sound from the unit.
- 4) **Temperature** - Select the desired temperature by pressing either ▼ or ▲ key when using the unit in cooling or heating mode. The temperature indicator flashes to display the desired temperature setting. After the temperature is set, the unit will display this temperature setting until it is changed by the user. The led control display shows temperature in Celsius or Fahrenheit. Press the ▼ and ▲ simultaneously to change from °C to °F.
- 5) **TIMER*** - To program the Auto-on timer, first press the **TIMER** button when the unit is off. Once the **TIMER** button is pressed the hours will blink on the display. Press the ▼ or ▲ buttons to change the number to the desired hours for the unit to automatically turn on. To program the unit to turn off automatically press the **TIMER** button when the unit is on to set the off timer. The display will flash the hours to turn off the unit. Press the ▼ or ▲ buttons to change the hours to the desired time for the unit to automatically turn off. The timer is set when the auto-off time stops flashing.

*NOTE: For a more sophisticated clock timer, use the included LCD remote control.

OPERATING THE UNIT USING THE CONTROL PANEL

Air Conditioner Mode

- 1) Install the exhaust hose and window kit properly (see pages 7 & 8).
- 2) Plug the Power Cord into an electrical outlet.
- 3) Turn on the unit by pressing the **POWER** button on the control panel.
- 4) Press the Mode button until the “” icon appears on the led control display
- 5) Press the ▲ or ▼ buttons until the desired room temperature appears on the control panel display. The temperature ranges from 61 F - 88 F (16 C - 31 C).
- 6) Select the desired fan speed by pressing the **FAN** button.

NOTE: During hot days, the unit will cool the room most efficiently by setting the temperature at the lowest setting and the fan speed on high. Reducing the length of the exhaust duct, insulating the exhaust hose and window kit, and keeping direct sunlight to a minimum will also improve the cooling efficiency.

Heating Mode

- 1) Install the exhaust hose and window kit properly (see pages 7 & 8).
- 2) Plug the Power Cord into an electrical outlet.
- 3) Turn on the unit by pressing the **POWER** button on the control panel.
- 4) Press the **MODE** button until the “  ” icon appears on the control panel display.
- 5) Press the ▼ or ▲ buttons until the desired room temperature appears on the control panel display. The temperature ranges from 61° F - 88° F (16° C - 31° C).
- 6) Select the fan speed by pressing the **FAN** button. It is recommended to set the fan speed to low.

NOTE: When heat mode is selected, the unit will shut down for 3-5 minutes, then start in heating mode.

NOTE: When the unit is running on heating mode, the exhaust hose is required and must be vented outside using the supplied window kit.

Dehumidifier Mode

- 1) Install the exhaust hose and window kit properly (see pages 7 & 8).
- 2) Plug the Power Cord into an electrical outlet.
- 3) Turn on the unit by pressing the **POWER** Button on the control panel.
- 4) Press the **MODE** button until the “  ” appears on the control panel display.

NOTE: The unit operates at low fan speed during dehumidifier mode. The unit cools room slightly during while dehumidifying. Keep the windows and doors closed to aid the effectiveness of the unit as it removes moisture from the room.

NOTE: The unit will not perform in dehumidifier mode when the room temperature is lower than 61° F .

Fan Mode

- 1) Plug the Power Cord into an electrical outlet.
- 2) Turn on the unit by pressing the **POWER** button on the control panel.
- 3) Press the **MODE** button until the “  ” icon appears on the control panel display.
- 4) Select the fan speed by pressing the **FAN** button.
- 5) To circulate more air, press the **SWING** button on the remote control. (The louvers will oscillate up and down)

NOTE: It is not necessary for the exhaust hose and window kit to be installed to operate the unit in fan mode.

Auto Mode

- 1) Install the exhaust hose and window kit properly (see pages 7 & 8).
- 2) Plug the Power Cord into an electrical outlet.
- 3) Turn on the unit by pressing the **POWER** button on the control panel.
- 4) Press the **MODE** button until the “  ” icon appears on the control panel display. Select the fan speed by pressing the **FAN** button.



NOTE: During AUTO mode, the unit operates in **Dehumidifier** mode when the room temperature is between

68 °F to 80 °F. And **Air Conditioner** mode when the room temperature is above 80 °F. Heating Mode when the room temperature is below 68 °F.

Sleep Mode (This mode can only be selected when using the Remote control)

- 1) To set Sleep mode, make sure the unit is in Air Conditioner mode or Heating mode.
- 2) Press the **SLEEP** Button on the remote control. The “” icon appears on the control panel display.
- 3) When in **SLEEP** mode, the fan will run on low to keep fan noise at a minimum.
- 4) When in Air Conditioner mode, the temperature setting will gradually increase to 2 °F above the original set temperature for 6 hours. After 6 hours the temperature setting will return to the set temperature.
- 5) When in Heating mode, the temperature setting will gradually decrease to 2 °F below the original set temperature for 6 hours. After 6 hours, the temperature setting will return to the set temperature.
- 6) When in Dehumidifier mode, the temperature will not change when Sleep mode is selected.

Compressor Indicator

The “” icon will light up on the control panel display when the compressor turns on. The “” icon will turn off when the compressor shuts off.

Emergency Condensate Holding Tank

When the room temperature is low and the indoor humidity is high, the air conditioner may not be able to evaporate some of the moisture fast enough. When this happens, the water will accumulate in an emergency condensate tank inside the unit. Once the emergency condensate tank is full, the unit will automatically shut

off and the “” will appear on the control panel display. To empty the condensate tank, pull the drain plug at the bottom back of the unit. You will need a small pan, approximately 1” high to catch the water coming out of the condensate tank. Connect the supplied drainage hose to the back of the unit to aid in drainage into the pan. Once the condensate tank is drained, the unit will begin working within a few minutes. The emergency condensate tank is approximately 1.5 Liters of water. Another option is to purchase a small hose from a hardware store that can fit around the 5/8” drain plug on the back of the unit and drain the unit into a gravity drain or larger pan for continuous drainage. It is not advised to use continuous drainage when the room temperature is higher than 90 °F.

If you do not need the emergency tank emptied immediately simply leave the unit on. The fan in your air conditioner will continue to run to help evaporate the moisture as fast as possible. This will usually take around 60 minutes depending on how much water is in the tank.

OPERATING THE UNIT USING THE REMOTE CONTROL

REMOTE CONTROL

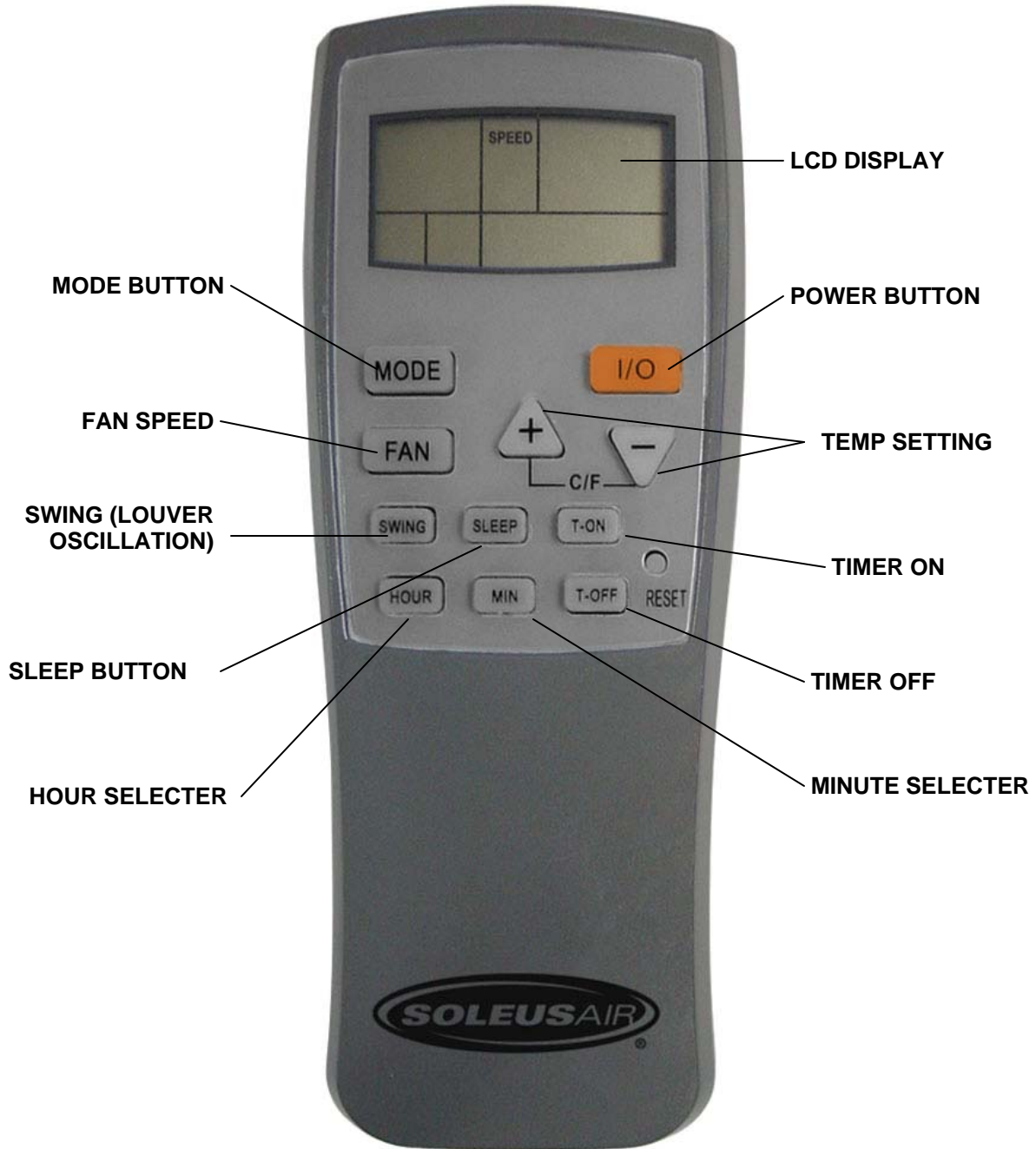

* Remote color may differ from the image above.

REMOTE CONTROL OPERATING INSTRUCTIONS

- 1) **Power On and Off** - Press the **POWER (I/O)** button once to manually turn the unit on. Press the Power button once more to turn the unit off. When you press the **POWER** button the upper right square on the remote control LED Display will light up. When in Air Conditioner and Auto mode, the selected temperature will appear on the remote control display. When the unit is in Fan mode and Dehumidifier mode you will see the “- -” icon instead of the set temperature. This shows that temperature selection is not available when the unit is in Fan or Dehumidifier mode.
- 2) **Mode Selection** - Press the **MODE** Button repeatedly to cycle between the different modes: Auto, Air Conditioner, Dehumidifier, Fan only, and Heater mode. The upper left square on the Remote control display will light up showing which mode is selected. In Air Conditioner mode the display will show “COOL”, in Heating mode the display will show “HEAT”, in Dehumidifier mode the display will show “DRY”, in Fan mode the display will show “FAN”, and in Auto mode the display will show “AUTO”.
- 3) **Fan Speed** - Press the **FAN** speed button to cycle through high, medium, and low fan speeds. The display on the remote control will show HIGH, MED, & LOW under the “SPEED” label on the remote control LCD display. There is an additional **auto** speed setting that is enabled in only heating and cooling modes. This speed is next setting after low when pressing the **FAN** speed button on the remote control. The speeds will cycle through in this order: **High, Medium, Low, Auto**. Each change in speed will be associated with a “beep” sound from the unit. The remote control will not display “AUTO” under the speed label. Once Auto fan speed is selected the unit will beep and there will not be a fan speed displayed on the remote control.
- 4) **Temperature Setting** - When the unit is in Air Conditioner or Heating mode you can select your desired temperature. Press the ▲ or ▼ to select your desired temperature setting. The temperature on the LCD display on the remote control will increase or decrease accordingly. Pressing the ▼ and ▲ buttons simultaneously will change the temperature select between °F and °C.
- 5) **SLEEP MODE** - See “SLEEP MODE” on page 12.
- 6) **SWING** - To turn on oscillation, press the **SWING** button on the remote control. Once you press **SWING** button, the louvers on the unit will oscillate up and down “↑↓”. To change the horizontal direction of the air flow manually adjust the internal horizontal louvers left or right. Once **SWING** is selected the “↔” icon will show up on the LCD display on the remote control.
- 7) **CLOCK** - To set the clock on the remote control, hold down either the **MIN** or **HOUR** button until the displayed time flashes on the remote control display. Change the minutes by pressing the **MIN** button and change the hours by pressing the **HOUR** button. Set the clock prior to programming the timer.
- 8) **TIMER** - After setting the clock, you are ready to program the timer. program the timer, first press the **T-ON** button when the unit is off. Once **T-ON** is pressed the auto-on timer will blink in the bottom right rectangle of the remote control display. Press the **MIN** and **HOUR** buttons to change the clock to the desired time for the unit to automatically turn on. The minutes will increase by 10 with each press of the **MIN** button and the hours will increase by 1 with each press of the **HOUR** button. Press the **T-OFF** button when the unit is on to set the off timer. The remote control display will flash the desired auto-off timer. Press the **MIN** and **HOUR** buttons to change the clock to the desired time for the unit to automatically turn off. The timer is set when the auto-off time stops flashing and the words “ON” and “OFF” are displayed next to the time.

MAINTENANCE

Note: Make sure power is off and the power cord is not plugged into an electrical outlet prior to performing any maintenance on the unit.

Clean or replace filter - If the air filter is blocked with a dust, the airflow volume may reduce. It is recommended to clean the filter once every two weeks or as needed.

- 1) Remove the filter from the filter compartment on the front of the unit.
- 2) Wash the air filter by immersing it gently into warm water with a neutral detergent. Rinse the filter and dry it thoroughly out of sunlight.
- 3) Slide the filter back into the filter compartment after it is thoroughly dried.
- 4) If the filter is torn or unusable, order a new filter by calling the customer service number on the warranty page of this manual.

Clean the unit Housing

- 1) Keep the unit from being exposed directly to the sun to prevent color fading.
- 2) Clean the surface with a damp cloth and dry it with a soft towel.

Storing the Unit for an Extended Period of Time or Transporting the unit

- 1) Empty any excess water by unplugging the water drainage stop in the back of the unit (located at the bottom).
- 2) Unplug the unit.
- 3) The unit should be stored in a cool dry place.

DISCLAIMER

ALL INFORMATION AND THE TECHNICAL SPECIFICATIONS PRESENTED IN THIS USER'S MANUAL ARE THE PRESENTATION OF THE MANUFACTURER. SOLEUS INTERNATIONAL HAS NOT CONDUCTED INDEPENDENT TEST TO THE INFORMATION AND THE SPECIFICATIONS PRESENTED HEREWITHIN.

WARRANTY

One Year Limited Warranty

Soleus International Inc. warrants the accompanying Soleus Air PH5 Series Portable Air Conditioner to be free of defects in material and workmanship for the applications specified in its operation instruction for a period of ONE (1) year from the date of original retail purchase in the United States.

If the unit exhibits a defect in normal use, Soleus International Inc. will, at its option, either repair or replace it, free of charge within a reasonable time after the unit is returned during the warranty period.

As a condition to any warranty service obligation, the consumer must present this Warranty Certificate along with a copy of the original purchase invoice.

THIS WARRANTY DOES NOT COVER:

- Damage, accidental or otherwise, to the unit while in the possession of a consumer not caused by a defect in material or workmanship.
- Damage caused by consumer misuse, tampering, or failure to follow the care and special handling provisions in the instructions.
- Damage to the finish of the case, or other appearance parts caused by wear.
- Damage caused by repairs or alterations of the unit by anyone other than those authorized by Soleus International Inc.
- Freight and Insurance cost for the warranty service.

ALL WARRANTIES, INCLUDING ANY IMPLIED WARRANTY OF MERCHANTABILITY ARE LIMITED TO ONE-YEAR DURATION OF THIS EXPRESS LIMITED WARRANTY. **SOLEUS INTERNATIONAL INC.** DISCLAIMS ANY LIABILITY FOR CONSEQUENTIAL OR INCIDENTAL DAMAGES AND IN NO EVENT SHALL SOLEUS INTERNATIONAL INC'S LIABILITY EXCEED THE RETAIL VALUE OF THE UNIT FOR BREACH OF ANY WRITTEN OR IMPLIED WARRANTY WITH RESPECT TO THIS UNIT.

This warranty covers only new products purchased from our authorized dealers or retailers. It does not cover used, salvaged, or refurbished products.

As some states do not allow the limitation or exclusion of incidental or consequential damages, or do not allow limitation on implied warranties, the above limitations and exclusions may not apply to you. This warranty gives you specific legal rights, and you may also have other rights that vary from state to state.

For Technical Support & Warranty Service

Please Call (888) 876-5387

Or Write To:

Soleus International Inc.

20035 E. Walnut Dr. N.

City of Industry, CA 91789 USA

www.soleusair.com